

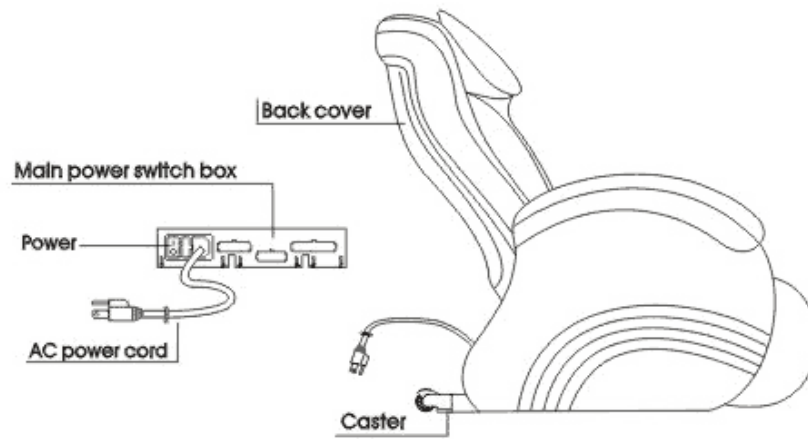

FEATURES

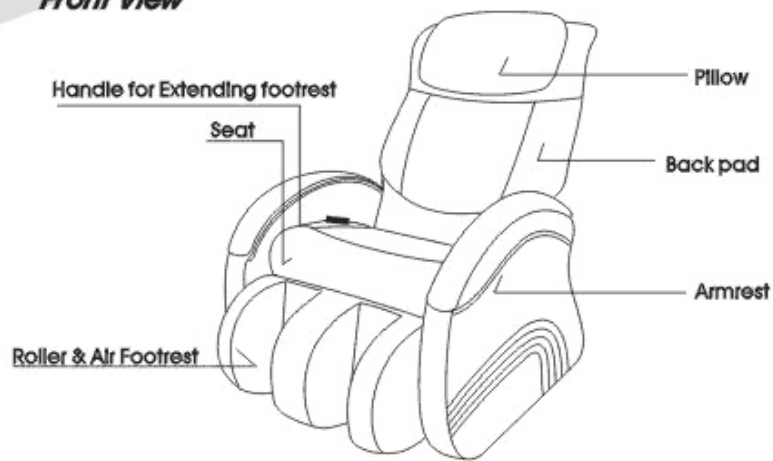







Front View









LCD FEATURES

 AUTOMATIC	Automatic	 <p>LCD Display Screen</p>
	Timer	
	Positions of massage rollers	
	Rollers' width	
	Speed level	
	Direction of massage rollers	
	Back heat	 Rolling
	Back Air	 Dual action
	Thigh Air	 Air massage level
	Calf Air	 Backrest reclining
	Kneading	 Footrest reclining
	Tapping	 Footrest roller





PRODUCT FUNCTION AND DESCRIPTION

- ①  **Power (Start / Stop)**
Press the button to turn on/off the chair. The LCD shows "00" when the chair is on. When using the chair, press the button to reset the chair to fully upright position, and return to standby "00" mode.
- ②  **Special Function: Health Massage**
Press the button to turn on/off the 30-minute programmed massage, and the LCD shows the resting time and the functioning massage.
- ②  Before massage, the massage chair would turn on automatic shoulder detection. This is to locate the acupuncture points of the user and provide the most comfortable massage. The function would automatically adjust the width and speed of massage rollers. When the roller is upper the shoulder, the manual adjustment for width is not available. (See LCD features)
- ③  **Roller Positioning Upward**
When using the manual function, press and hold the button to adjust positions of the roller upward to the desired position, and then, release the button. (Not available for Special and Auto functions)
- ③  **Roller Positioning Downward**
When using the manual function, press and hold the button to adjust positions of the rollers downward to the desired position, and then, release the button. (Not available for Special and Auto functions)
- ④  **Rolling/Speed**
Press the button to turn on/off the chiropractic-like massage function with the time setting from 5 to 30 minutes, and adjust the up-and-down speed of rollers (not available for fixed massage). Pressing "Intensity" could adjust the speed as well, and the speed would be shown on the LCD with 3-second display. The rolling width would be narrowed automatically as the roller moves upper the shoulder if the WIDE rolling is set. The rolling width remains the same if the MEDIUM or NARROW is set.



PRODUCT FUNCTION AND DESCRIPTION

- ⑤  **Width Adjustment**
Width adjustment for tapping and rolling. User can select wide, medium or narrow for personal comfortability. It is not available for the kneading and dual functions, and the Special and Auto functions. The manual adjustment for narrowing is not available when the roller is upper the shoulder.
- ⑥  **Back Vibration**
Press the button to turn on/off the function. Press again to select the strong/weak vibrating intensity. (See the LCD features. The function is not available for Special and Auto functions.)
- ⑦  **Backrest Adjustment**
Press and hold the up or down arrow to adjust the angle of the backrest. Double-click can synchronize the movement of the backrest and footrest. (The function is available even though the power of remote controller is off.)
- ⑧  **Back Warmer**
Press the button to turn on/off the warming device in the backrest. The device can work with other functions. (Please refer to the Instruction on Page 21)
- ⑨  **Timer**
Press the button to set the massage time from 5 to 30 minutes with 5-minute interval.
- ⑩  **Special Function: Fitness**
Press the button to turn on/off the function. The 15-minute program is preset. The LCD would show the progress and the time left. The programmed massage would automatically adjust the width and the speed of roller for the user.
- Before massage, the massage chair would turn on automatic shoulder detection. This is to locate the acupuncture points of the user and provide the most comfortable massage.
- The function would automatically adjust the width and speed of massage rollers. When the roller is upper the shoulder, the manual adjustment for width is not available. (See LCD features)



PRODUCT FUNCTION AND DESCRIPTION

- ⑪  **Special Function: Rest Time**
Press the button to turn on/off the function. The preset time is 10 minutes, but it is manually adjustable up to 99 minutes. The LCD would show the progress and the time left. In the first 3-minute massage, the programmed massage would automatically adjust the width and the speed of roller for the user. After the first 3-minute massage, the massage would be off automatically, so the user can have a short rest. In the last 3 minutes, the massage chair would function to wake up the user. (See LCD features)
- ⑫  **Auto**
Press the button to turn on the function for whole, partial back, shoulders, waist, or fixed point. The pre-set time is 15 minutes, shown on the LCD screen.
The flashing LED indicated the working function user selected. The massaging width and speed are adjusted automatically by the pre-set program. Before massage, the massage chair would turn on automatic shoulder detection. This is to locate the acupuncture points of the user and provide the most comfortable massage. The function would automatically adjust the width and speed of massage rollers. When the roller is upper the shoulder, the manual adjustment for width is not available. (See LCD features)
- ⑬  **Manual**
Press the button to select the functions for whole back, partial back, shoulders, waist, to fixed point. The pre-set time is 15 minutes, and it is adjustable up to 30 minutes. The selected functions are also shown on the panel through LED flashing. The user can also select different function at once.
- ⑭  **Kneading**
Press the button to turn on/off the function. One click the button leads the kneading and inward rotating massage and double-click does the kneading and outward rotating massage. User can select the different functions at once. The selected function would be shown by the flashing LED. While the kneading is selected, user can adjust the speed of roller by press the ROLLING/SPEED. There are 6 speeds available. The selected speed is shown on the LCD with 3-second display. (See LCD features)

PRODUCT FUNCTION AND DESCRIPTION

- 15**  **Tapping**
Press the button to turn on/off the function. User can select different manual massages at once, and set the time from 5 to 30 minutes. While the tapping is selected, user can adjust the speed of roller by press the ROLLING/SPEED. There are 6 speeds available. The selected speed is shown on the LCD with 3-second display. The manual adjustment to narrow the roller is not available when the roller is upper the shoulder. (See LCD features)
- 16**  **Dual Action**
Press the button to turn on/off the function combining the tapping and kneading massage, and the time is adjustable from 5 to 30 minutes.
Clicking the button once leads the kneading and inward rotating massage and duple-click does the kneading and ourward rotating massage.
While the kneading is selected, user can adjust the speed of roller by pressing the ROLLING/SPEED. There are 6 speeds available. The selected speed is shown on the LCD with 3-second display. (See LCD features)
- 17**  **Speed Adjustment**
There are 5 speeds available for tapping, kneading, and dual action. It is also available for rolling massage by clicking the Roller Positioning Upward/Downward or the ROLLING/SPEED. When the Special or Auto function is selected, the speed is controlled by the default massage programs.
- 18**  **Foot Kneading Roller**
Press the button to turn on/off the function with 3 speeds available. The function is capable to work with foot, seat and back air massage, and back massage. The time is adjustable from 5 to 30 minutes. (See LCD features)
- 19**  **Back Air Massage**
Press the button to turn on/off the function. It is capable to work with other functions except the back air massage. When the Special or Auto function is selected, the massage is controlled by the default program. (See LCD features)

PRODUCT FUNCTION AND DESCRIPTION

- 20  **Seat Air Massage**
Press the button to turn on/off the function. The seat air massage is to provide the right and left massage on the seat. When the Special or Auto function is selected, the massage is controlled by the default program. (See LCD features)
- 21  **Air Legs Massage**
Press the button to turn on/off the function, or select the weak/medium/ strong Intensity to massage. (See the display for Intensity on the LCD)
- 22  **Footrest Adjustment**
Press the button to control the footrest upward and downward. Double-click can synchronize the movement of backrest and footrest.

PRODUCT FUNCTION AND DESCRIPTION

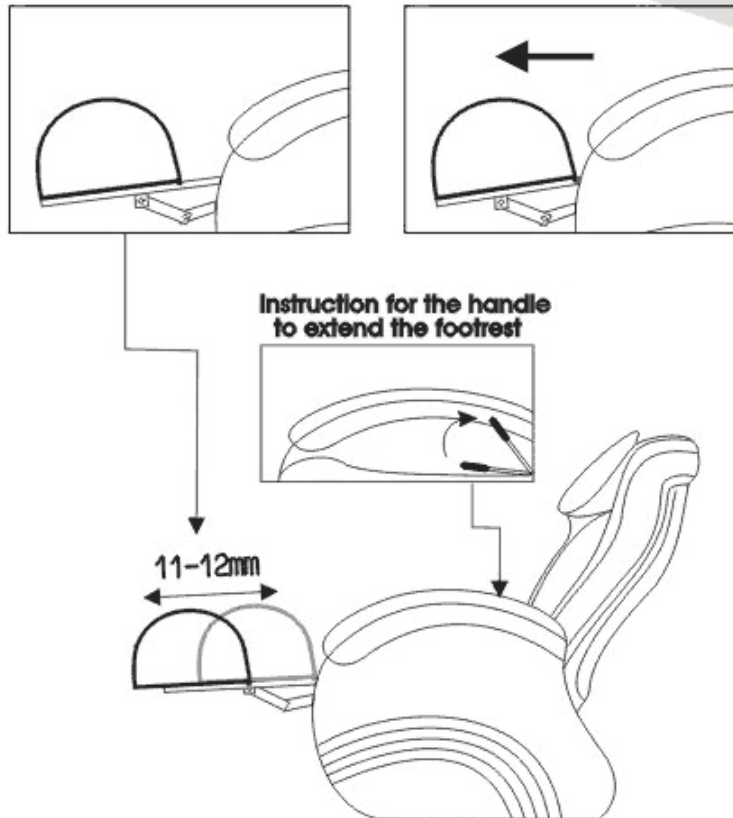

Instruction:

1. User can adjust the extendable footrest from 0mm to 120mm by pulling up the handle at the right side of seat cushion.
2. To prevent the injury or damage, DO NOT stand or step heavily on the footrest.